



Bentonite Mud Mixer Model M-750D

Surface to Surface Inc.



Features and Benefits

M-750D Mixer

The M-750D with its rectangular loaf shaped Roto-Mold tank, is a space saving design with almost square footprint dimensions. Powered by a 21.9 water cooled electric start diesel engine, driving a 4 inch centrifugal pump making effective use of the proprietary StS mixing system, this Bentonite Mud Mixer is capable of providing 750 gallons of full yield mud to your drill rig in less than eight (8) minutes. Added benefits to this unit include the ability to draw water from a second tank and send mud to your drilling rig or storage tank without the use of a second pump. Other power drives available.

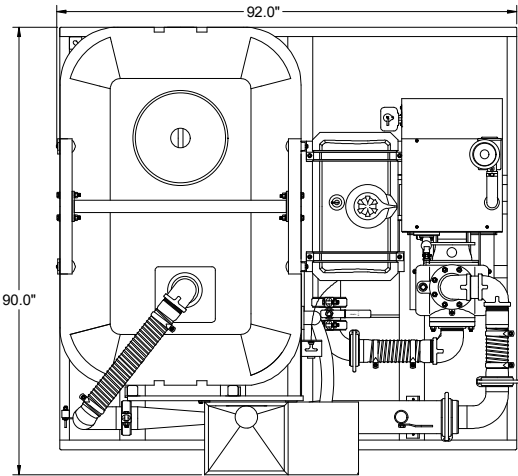

Specifications

- Dimensions
- Approx. Weight
- Hopper Height
- Mixing System
- Mixing Tank
- Skid frame
- Diesel Engine
- Pump
- Drive Coupling
- Mechanical Seal
- Replaceable Wear Plate
- Fuel Tank
- Pipe Couplers
- Pressure Wand
- Tank Drain

M-750 Mixer

- 92"W x 90"L x 75"H
- 2650 lbs.
- 42 inches high
- 4" Proprietary StS Mixing System
- 750 gallon Roto-Mold Polyethylene
- 5" Steel Channel, Welded
- 21.9 hp Water Cooled Electric Start
- 4" Cast Iron Centrifugal Trash Pump
- Direct Coupled Engine to Pump
- Self-Pressurizing Grease Seal
- Hardened plate ahead of Impeller
- 15 gal. Steel c/w Sight Gauge
- Bolt and Snap –Groove Type
- Hopper Maintenance Wand
- Bottom Tank Drain Supplied

Benefits

- Fits any 8' flat deck and makes efficient use of available space.
- Waist high hopper reduces back strain.
- Fast, efficient mixing time (7 min. mix).
- Minimal maintenance required.
- Built for the rigors of the construction trade.
- Water Cooled, Industrial rated for long service life.
- Rugged & Repairable for extended service life.
- No expensive couplers or inserts to replace.
- Greaseable seal for more rugged working conditions
- Less wear on internal pump parts and is replaceable.
- Provides a full day running on a fill up.
- Provide fast cold weather maintenance.
- Removal of any build-up caused by additives.
- Provides fast cold weather tank drainage.

Also available in Gasoline (M-750G) - Hydraulic (M-750H) – Electric (M-750E) models.

*** All Specifications Subject to Change Without Notice ***

Check our website for the latest products and specifications
www.stsmixers.com

Surface to Surface Inc.

5150 Forest Road, R.R.#3, Watford, Ontario, N0M 2S0
Tel: 1-800-567-0978

03/07/23